



Die-casting aluminum material

FOCUS ON SOLAR GARDEN LANDSCAPE LIGHTS

2023 Version



 BERT ITALIA S.R.L.



CONTENTS



P01~P26 SOLAR GARDEN LIGHT



P27~P28 SOLAR MICROWAVE SENSOR GARDEN LIGHT



P29~P38 SOLAR POLE LIGHT



P39~P44 SOLAR STREET LIGHT



P45~P66 SOLAR LAWN LIGHT



P67~P80 SOLAR WALL LIGHT



P81~P94 SOLAR PILLAR LIGHT



P95~P100 ELECTRICITY POWER SERIES LAMP EFFECT PICTURE





New

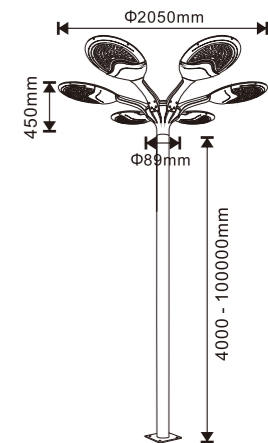
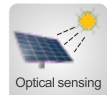

PRODUCT PARAMETERS

Model	ZC-TYD5109-6	ZC-TYD5109-3
Material	Die-casting aluminum	Die-casting aluminum
Solar panel	5V/150W	5V/75W
Battery	3.2V/180000mAh	3.2V/90000mAh
Quantity of LED chips	600PCS	300PCS
Charge time	3-5H	3-5H
Color temperature	3000-6500K	3000-6500K
Size	φ2050*H450mm	φ2050*H450mm





PRODUCT PARAMETERS

Model	ZC-TYD5105-6	ZC-TYD5105-3
Material	Die-casting aluminum	Die-casting aluminum
Solar panel	5V/96W	5V/48W
Battery	3.2V/120000mAh	3.2V/60000mAh
Quantity of LED chips	480PCS	240PCS
Charge time	3-5H	3-5H
Color temperature	3000-6500K	3000-6500K
Size	φ1660*H435mm	φ1660*H435mm



PRODUCT PARAMETERS

Model	ZC-TYD5106-6	ZC-TYD5106-3
Material	Die-casting aluminum	Die-casting aluminum
Solar panel	5V/66W	5V/33W
Battery	3.2V/80000mAh	3.2V/45000mAh
Quantity of LED chips	360PCS	180PCS
Charge time	3-5H	3-5H
Color temperature	3000-6500K	3000-6500K
Size	φ1260*H390mm	φ1260*H390mm





PRODUCT PARAMETERS

Model	ZC-TYD5105-6	ZC-TYD5105-3
Material	Die-casting aluminum	Die-casting aluminum
Voltage	220V	220V
Power	420W	210W
Quantity of LED chips	480PCS	240PCS
Rate frequency	50Hz	50Hz
Color temperature	3000-6500K	3000-6500K
Size	φ1660*H435mm	φ1660*H435mm





PRODUCT PARAMETERS

Model	ZC-TYD5106-6	ZC-TYD5106-3
Material	Die-casting aluminum	Die-casting aluminum
Voltage	220V	220V
Power	240W	150W
Quantity of LED chips	360PCS	180PCS
Rate frequency	50Hz	50Hz
Color temperature	3000-6500K	3000-6500K
Size	φ1660*H435mm	φ1660*H435mm





PRODUCT PARAMETERS

Model	ZC-TYD5108	ZC-TYD2808
Material	Die-casting aluminum	Die-casting aluminum
Solar panel	5V/25W	5V/38W
Battery	3.2V/36000mAh	3.2V/60000mAh
Quantity of LED chips	100PCS	150PCS
Charge time	3-5H	3-5H
Color temperature	3000-6500K	3000-6500K
Size	Φ630*Φ435*H495mm	Φ700*Φ520*H665mm



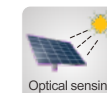
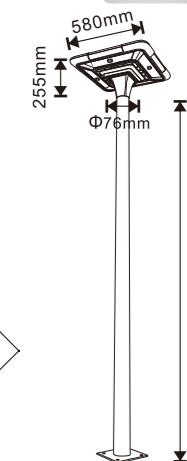
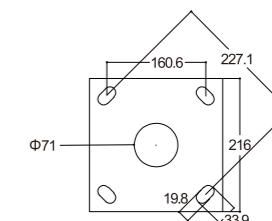

PRODUCT PARAMETERS

Model	ZC-TYD2505
Material	Die-casting aluminum
Solar panel	5V/45W
Battery	3.2V/60000mAh
Quantity of LED chips	208PCS
Charge time	3-5H
Color temperature	3000-6500K
Size	580*580*H255mm





New

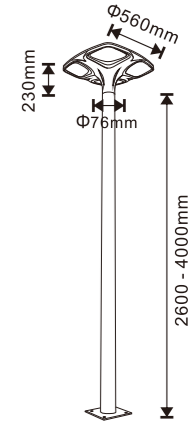
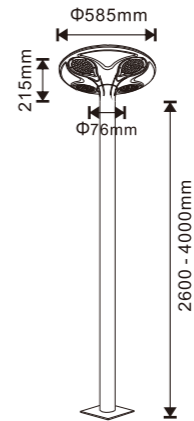

-  Solar energy
-  3.2V Voltage
-  Optical sensing

PRODUCT PARAMETERS

Model	ZC-TYD2806	ZC-GGD0805
Material	Die-casting aluminum	Die-casting aluminum
Solar panel	5V/30W	5V/32W
Battery	3.2V/45000mAh	3.2V/45000mAh
Quantity of LED chips	160PCS	160PCS
Charge time	3-5H	3-5H
Color temperature	3000-6500K	3000-6500K
Size	φ585*H215mm	φ560*H230mm





PRODUCT PARAMETERS

Model	ZC-TYD2705	ZC-TYD2403
Material	Die-casting aluminum+PC	Die-casting aluminum+PC
Solar panel	5V/20W	5V/25W
Battery	3.2V/20000mAh	3.2V/20000mAh
Quantity of LED chips	80PCS	80PCS
Charge time	3-5H	3-5H
Color temperature	3000-6500K	3000-6500K
Size	φ480*H410mm	400*400*H420mm





PRODUCT PARAMETERS

Model	ZC-GGD2005-2	ZC-GGD2005-3	ZC-GGD2005-4
Material	Die-casting aluminum	Die-casting aluminum	Die-casting aluminum
Solar panel	5V/21W	5V/28W	5V/35W
Battery	3.2V/20000mAh	3.2V/30000mAh	3.2V/40000mAh
Quantity of LED chips	80PCS	120PCS	160PCS
Charge time	3-5H	3-5H	3-5H
Color temperature	3000-6500K	3000-6500K	3000-6500K
Size	Φ1070*H3000mm	Φ960*H3000mm	Φ1070*H3000mm



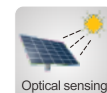
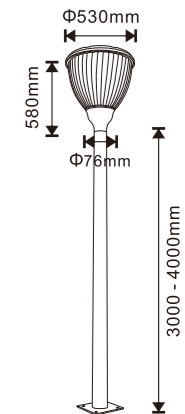
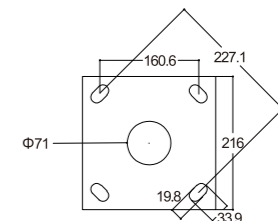

PRODUCT PARAMETERS

Model	ZC-TYD1105
Material	Die-casting aluminum+PC
Solar panel	5V/28W
Battery	3.2V/36000mAh
Quantity of LED chips	160PCS
Charge time	3-5H
Color temperature	3000-6500K
Size	φ530*H580mm





PRODUCT PARAMETERS

Model	ZC-GGD003-1	ZC-GGD003-2	ZC-TYD1104
Material	Die-casting aluminum+PC	Die-casting aluminum+PC	Die-casting aluminum+PC
Solar panel	5V/25W	5V/16W	5V/25W
Battery	3.2V/30000mAh	3.2V/16000mAh	3.2V/30000mAh
Quantity of LED chips	160PCS	80PCS	160PCS
Charge time	3-5H	3-5H	3-5H
Color temperature	3000-6500K	3000-6500K	3000-6500K
Size	Φ530*H490mm	Φ410*H383mm	Φ530*H440mm





New

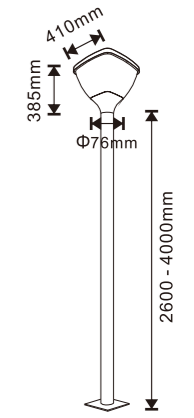
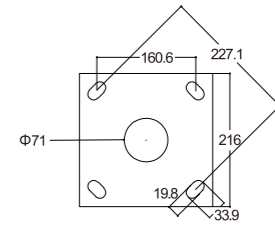

PRODUCT PARAMETERS

Model	ZC-TYD2508
Material	Die-casting aluminum+PC
Solar panel	5V/20W
Battery	3.2V/20000mAh
Quantity of LED chips	80PCS
Charge time	3-5H
Color temperature	3000-6500K
Size	410*410*H385mm



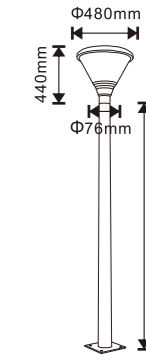
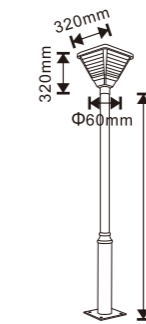
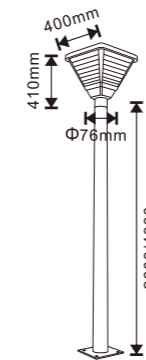

PRODUCT PARAMETERS

Model	ZC-GGD002-1	ZC-GGD002-2	ZC-GGD001
Material	Die-casting aluminum+PC	Die-casting aluminum+PC	Die-casting aluminum+PC
Solar panel	5V/20W	5V/12W	5V/20W
Battery	3.2V/20000mAh	3.2V/12000mAh	3.2V/20000mAh
Quantity of LED chips	80PCS	64PCS	80PCS
Charge time	3-5H	3-5H	3-5H
Color temperature	3000-6500K	3000-6500K	3000-6500K
Size	400*400*H410mm	320*320*H320mm	Φ480*H440mm





PRODUCT PARAMETERS

Model	ZC-TYD2808	ZC-TYD5108
Material	Die-casting aluminum	Die-casting aluminum
Solar panel	5V/38W	5V/25W
Battery	3.2V/60000mAh	3.2V/36000mAh
Quantity of LED chips	150PCS	100PCS
Working mode	Time control, Microwave sensor, Optical sensor	
Color temperature	3000-6500K	3000-6500K
Size	φ700*φ520*H665mm	φ630*φ435*H495mm



PRODUCT PARAMETERS

Model	ZC-TYD2705	ZC-TYD2403
Material	Die-casting aluminum	Die-casting aluminum
Solar panel	5V/20W	5V/25W
Battery	3.2V/20000mAh	3.2V/20000mAh
Quantity of LED chips	80PCS	80PCS
Working mode	Time control, Microwave sensor, Optical sensor	
Color temperature	3000-6500K	3000-6500K
Size	φ480*H410mm	400*400*H420mm



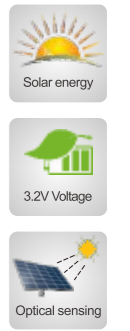

PRODUCT PARAMETERS

Model	ZC-GGD4205
Material	Die-casting aluminum+PC
Solar panel	5V/10W
Battery	3.2V/12000mAh
Quantity of LED chips	60PCS
Charge time	3-5H
Color temperature	3000-6500K
Size	300*300*H1000~2600mm





PRODUCT PARAMETERS

Model	ZC-GGD4505-1
Material	Die-casting aluminum+PC
Solar panel	5V/4.5W
Battery	3.2V/8000mAh
Quantity of LED chips	30PCS
Charge time	3-5H
Color temperature	3000-6500K
Size	Φ260*H1000/2500mm





PRODUCT PARAMETERS

Model	ZC-GGD4505-2	ZC-GGD4505-3
Material	Die-casting aluminum+PC	Die-casting aluminum+PC
Solar panel	5V/9W	5V/13.5W
Battery	3.2V/16000	3.2V/2400mAh
Quantity of LED chips	60PCS	90PCS
Charge time	3-5H	3-5H
Color temperature	3000-6500K	3000-6500K
Size	Φ800*H2600mm	Φ750*H2600mm





PRODUCT PARAMETERS

Model	ZC-GGD0203-1	ZC-GGD0203-2	ZC-GGD0203-3
Material	Die-casting aluminum+PC	Die-casting aluminum+PC	Die-casting aluminum+PC
Solar panel	5V/4.5W	5V/9W	5V/13.5W
Battery	3.2V/8000mAh	3.2V/16000mAh	3.2V/24000mAh
Quantity of LED chips	30PCS	60PCS	90PCS
Charge time	3-5H	3-5H	3-5H
Color temperature	3000-6500K	3000-6500K	3000-6500K
Size	Φ260*H1000~2500mm	Φ800*H2600mm	Φ750*H2600mm



PRODUCT PARAMETERS

Model	ZC-GGD4105-1	ZC-GGD4105-2	ZC-GGD4105-3
Material	Die-casting aluminum+PC	Die-casting aluminum+PC	Die-casting aluminum+PC
Solar panel	5V/4.5W	5V/9W	5V/13.5W
Battery	3.2V/8000mAh	3.2V/16000mAh	3.2V/24000mAh
Quantity of LED chips	30PCS	60PCS	90PCS
Charge time	3-5H	3-5H	3-5H
Color temperature	3000-6500K	3000-6500K	3000-6500K
Size	Φ260*H1000~2500mm	Φ800*H2600mm	Φ750*H2600mm





PRODUCT PARAMETERS

Model	ZC-GGD2806-1	ZC-GGD2806-2	ZC-GGD2806-3
Material	Die-casting aluminum+PC	Die-casting aluminum+PC	Die-casting aluminum+PC
Solar panel	5V/5W	5V/10W	5V/15W
Battery	3.2V/8000mAh	3.2V/16000mAh	3.2V/24000mAh
Quantity of LED chips	30PCS	60PCS	90PCS
Charge time	3-5H	3-5H	3-5H
Color temperature	3000-6500K	3000-6500K	3000-6500K
Size	235*235*H1000~2500mm	Φ795*H2600mm	Φ750*H2600mm

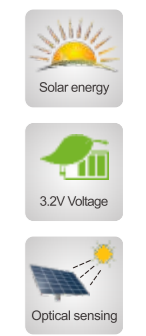



PRODUCT PARAMETERS

Model	ZC-GGD2806-1	ZC-GGD2806-2	ZC-GGD2806-3
Material	Die-casting aluminum+PC	Die-casting aluminum+PC	Die-casting aluminum+PC
Solar panel	5V/5W	5V/10W	5V/15W
Battery	3.2V/8000mAh	3.2V/16000mAh	3.2V/24000mAh
Quantity of LED chips	30PCS	60PCS	90PCS
Charge time	3-5H	3-5H	3-5H
Color temperature	3000-6500K	3000-6500K	3000-6500K
Size	235*235*H1000~2500mm	Φ795*H2600mm	Φ750*H2600mm

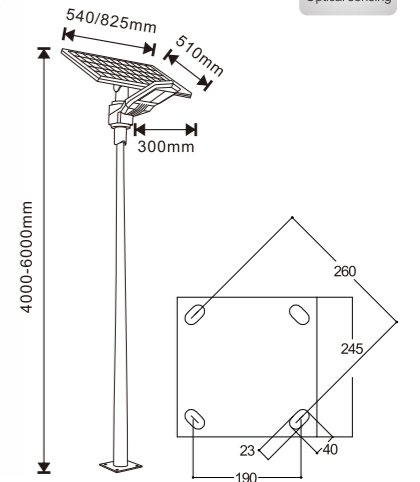

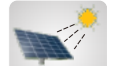

-  Solar energy
-  3.2V Voltage
-  Optical sensing

PRODUCT PARAMETERS

Model	ZC-XYD424	ZC-XYD436	ZC-XYD448
Material	Die-casting aluminum	Die-casting aluminum	Die-casting aluminum
Solar panel	5V/40W	5V/50W	5V/60W
Battery	3.2V/20000mAh	3.2V/40000mAh	3.2V/60000mAh
Quantity of LED chips	24PCS	48PCS	76PCS
Charge time	3-5H	3-5H	3-5H
Color temperature	3000-6500K	3000-6500K	3000-6500K
Size	610*200*390mm	610*200*390mm	610*200*390mm

- 
- 
- 
- 
- 
- 

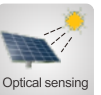
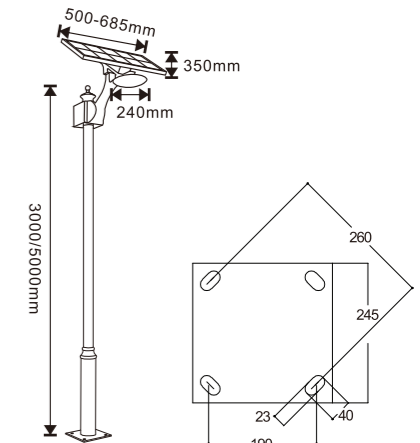

PRODUCT PARAMETERS

Model	ZC-TED0112	ZC-TED0118	ZC-TED0124
Material	Die-casting aluminum	Die-casting aluminum	Die-casting aluminum
Solar panel	5V/25W	5V/35W	5V/40W
Battery	3.2V/20000mAh	3.2V/30000mAh	3.2V/40000mAh
Quantity of LED chips	120PCS	120PCS	120PCS
Charge time	3-5H	3-5H	3-5H
Color temperature	3000-6500K	3000-6500K	3000-6500K
Size	500*350*240mm	630*350*240mm	680*350*240mm



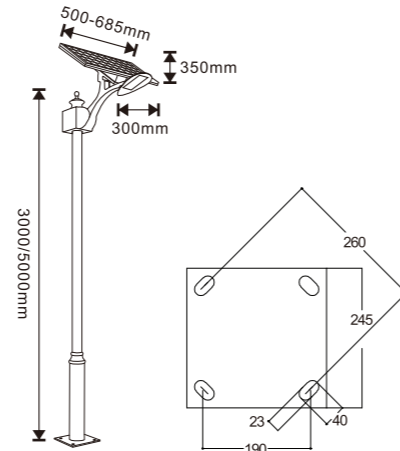

PRODUCT PARAMETERS

Model	ZC-TGD0215	ZC-TGD0224	ZC-TGD0230
Material	Die-casting aluminum	Die-casting aluminum	Die-casting aluminum
Solar panel	5V/25W	5V/35W	5V/40W
Battery	3.2V/20000mAh	3.2V/30000mAh	3.2V/40000mAh
Quantity of LED chips	24PCS	24PCS	24PCS
Charge time	3-5H	3-5H	3-5H
Color temperature	3000-6500K	3000-6500K	3000-6500K
Size	500*350*300mm	630*350*300mm	685*350*300mm

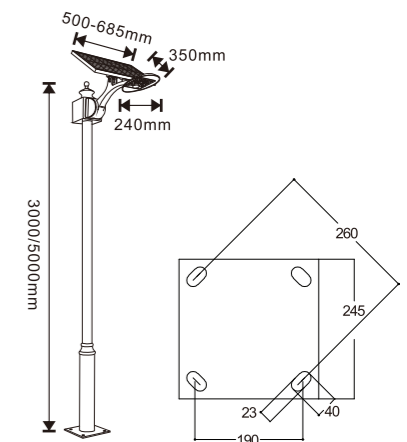

PRODUCT PARAMETERS

Model	ZC-TYD1215	ZC-TED1224	ZC-TED1230
Material	Die-casting aluminum	Die-casting aluminum	Die-casting aluminum
Solar panel	5V/25W	5V/35W	5V/40W
Battery	3.2V/20000mAh	3.2V/30000mAh	3.2V/40000mAh
Quantity of LED chips	120PCS	120PCS	120PCS
Charge time	3-5H	3-5H	3-5H
Color temperature	3000-6500K	3000-6500K	3000-6500K
Size	500*350*320mm	630*350*320mm	685*350*320mm





PRODUCT PARAMETERS

Model	ZC-CPD0804	ZC-CPD3004
Material	Die-casting aluminum+PC	Die-casting aluminum+PC
Solar panel	5V/2W	5V/2W
Battery	3.2V/3000mAh	3.2V/3000mAh
Quantity of LED chips	20PCS	20PCS
Charge time	3-5H	3-5H
Color temperature	3000-6500K	3000-6500K
Size	Φ185*H500/700mm	Φ185*H500/700mm





PRODUCT PARAMETERS

Model	ZC-CPD0907	ZC-CPD0705
Material	Die-casting aluminum+PC	Die-casting aluminum+PC
Solar panel	5V/2W	5V/2W
Battery	3.2V/3000mAh	3.2V/3000mAh
Quantity of LED chips	20PCS	20PCS
Charge time	3-5H	3-5H
Color temperature	3000-6500K	3000-6500K
Size	Φ185*H500/700mm	Φ185*H500/700mm





New



PRODUCT PARAMETERS

Model	ZC-CPD3008
Material	Die-casting aluminum
Solar panel	5V/5W
Battery	3.2V/8000mAh
Quantity of LED chips	30PCS
Charge time	3-5H
Color temperature	3000-6500K
Size	235*150*H600/800/1000mm



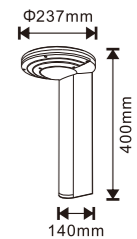
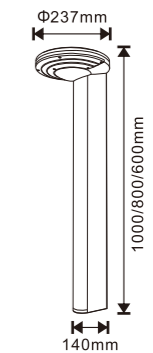
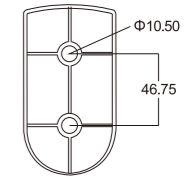

Solar energy



3.2V Voltage

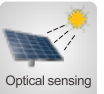

Optical sensing

PRODUCT PARAMETERS

Model	ZC-CPD8804
Material	Die-casting aluminum
Solar panel	5V/4.5W
Battery	3.2V/6000mAh
Quantity of LED chips	40PCS
Charge time	3-5H
Color temperature	3000-6500K
Size	237*140*H400/600/800/1000mm



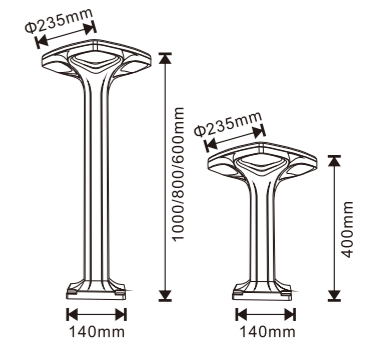
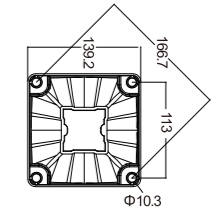

Solar energy



3.2V Voltage

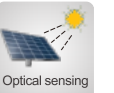

Optical sensing

PRODUCT PARAMETERS

Model	ZC-CPD2804
Material	Die-casting aluminum
Solar panel	5V/5W
Battery	3.2V/6000mAh
Quantity of LED chips	40PCS
Charge time	3-5H
Color temperature	3000-6500K
Size	235*140*H400/600/800/1000mm



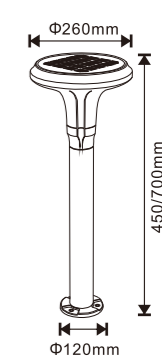
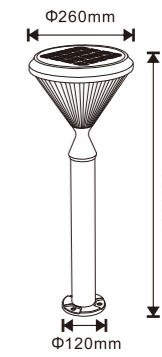
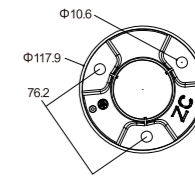

PRODUCT PARAMETERS

Model	ZC-CPD5405	ZC-CPD1004
Material	Die-casting aluminum+PC	Die-casting aluminum+PC
Solar panel	5V/4.5W	5V/4.5W
Battery	3.2V/8000mAh	3.2V/8000mAh
Quantity of LED chips	30PCS	12PCS
Charge time	3-5H	3-5H
Color temperature	3000-6500K	3000-6500K
Size	Φ260*Φ120*H500/750mm	Φ260*Φ120*H450/700mm





New

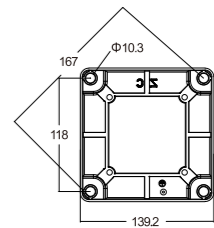

Solar energy



3.2V Voltage

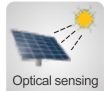

Optical sensing

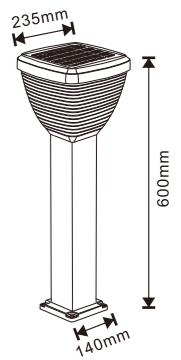
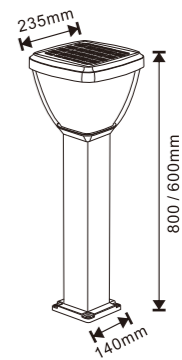

PRODUCT PARAMETERS

Model	ZC-CPD1106-1	ZC-CPD1106-2
Material	Die-casting aluminum+PC	Die-casting aluminum+PC
Solar panel	5V/5W	5V/5W
Battery	3.2V/8000mAh	3.2V/8000mAh
Quantity of LED chips	30PCS	30PCS
Charge time	3-5H	3-5H
Color temperature	3000-6500K	3000-6500K
Size	235*140*H600/800mm	235*140*H600/800mm



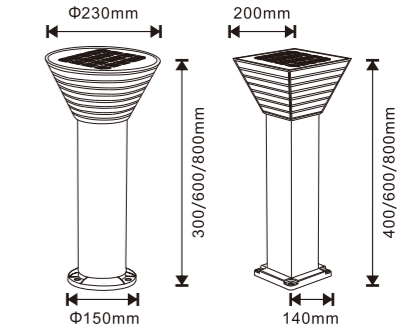
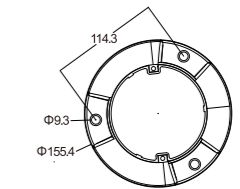
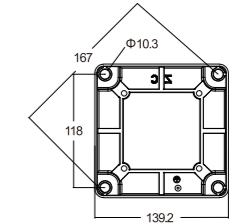

PRODUCT PARAMETERS

Model	ZC-CPD3004	ZC-CPD5004
Material	Die-casting aluminum+PC	Die-casting aluminum+PC
Solar panel	5V/4.5W	5V/5W
Battery	3.2V/6000mAh	3.2V/6000mAh
Quantity of LED chips	20PCS	30PCS
Charge time	3-5H	3-5H
Color temperature	3000-6500K	3000-6500K
Size	Φ230*Φ150*H300/600/800mm	200*140*H400/600/800mm





PRODUCT PARAMETERS

Model	ZC-CPD4104	ZC-CPD2204
Material	Die-casting aluminum+PC	Die-casting aluminum+PC
Solar panel	5V/4.5W	5V/4.5W
Battery	3.2V/8000mAh	3.2V/8000mAh
Quantity of LED chips	30PCS	30PCS
Charge time	3-5H	3-5H
Color temperature	3000-6500K	3000-6500K
Size	Φ260*Φ150*H350/650/850mm	Φ260*Φ150*H350/650/850mm



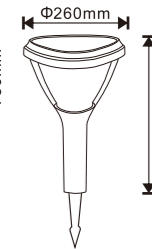
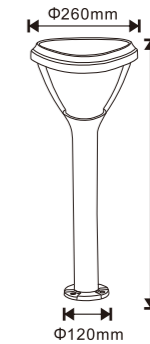
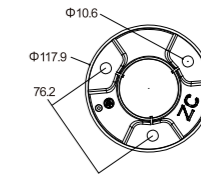

Solar energy



3.2V Voltage



Optical sensing

PRODUCT PARAMETERS

Model	ZC-CPD2104
Material	Die-casting aluminum+PC
Solar panel	5V/4.5W
Battery	3.2V/8000mAh
Quantity of LED chips	30PCS
Charge time	3-5H
Color temperature	3000-6500K
Size	Φ260*Φ120*H500/750mm



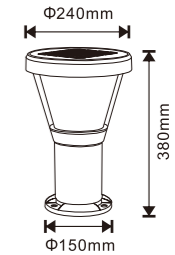
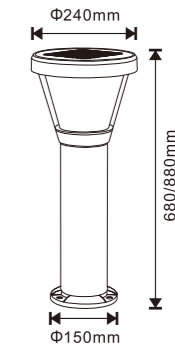
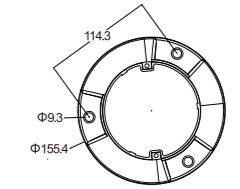

Solar energy



3.2V Voltage

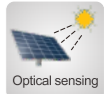

Optical sensing

PRODUCT PARAMETERS

Model	ZC-CPD2106
Material	Die-casting aluminum+PC
Solar panel	5V/4.5W
Battery	3.2V/8000mAh
Quantity of LED chips	30PCS
Charge time	3-5H
Color temperature	3000-6500K
Size	Φ240*Φ150*H380/680/880mm





New

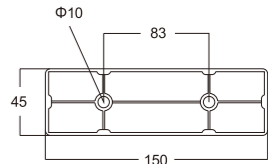

PRODUCT PARAMETERS

Model	ZC-BD1006
Material	Die-casting aluminum
Solar panel	5V/5W
Battery	3.2V/8000mAh
Quantity of LED chips	30PCS
Charge time	3-5H
Color temperature	3000-6500K
Size	235*150*H130mm



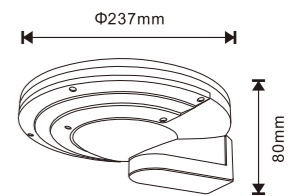
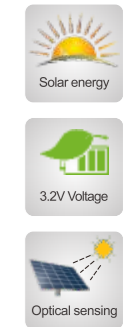

PRODUCT PARAMETERS

Model	ZC-BD1008
Material	Die-casting aluminum
Solar panel	5V/4.5W
Battery	3.2V/6000mAh
Quantity of LED chips	40PCS
Charge time	3-5H
Color temperature	3000-6500K
Size	Φ237*H80mm





PRODUCT PARAMETERS

Model	ZC-BD4005	ZC-BD1004
Material	Die-casting aluminum+PC	Die-casting aluminum+PC
Solar panel	5V/4.5W	5V/4.5W
Battery	3.2V/8000mAh	3.2V/8000mAh
Quantity of LED chips	30PCS	12PCS
Charge time	3-5H	3-5H
Color temperature	3000-6500K	3000-6500K
Size	Φ260*H370mm	Φ260*H330mm



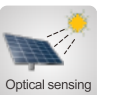
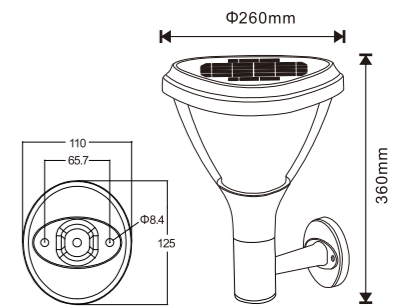

PRODUCT PARAMETERS

Model	ZC-BD2104
Material	Die-casting aluminum+PC
Solar panel	5V/4.5W
Battery	3.2V/8000mAh
Quantity of LED chips	30PCS
Charge time	3-5H
Color temperature	3000-6500K
Size	Φ260*H360mm





PRODUCT PARAMETERS

Model	ZC-BD2106-1	ZC-BD2106-2
Material	Die-casting aluminum+PC	Die-casting aluminum+PC
Solar panel	5V/4.5W	5V/4.5W
Battery	3.2V/8000mAh	3.2V/8000mAh
Quantity of LED chips	30PCS	30PCS
Charge time	3-5H	3-5H
Color temperature	3000-6500K	3000-6500K
Size	Φ240*H450mm	Φ240*H320mm





PRODUCT PARAMETERS

Model	ZC-BD4001	ZC-BD1104
Material	Die-casting aluminum+PC	Die-casting aluminum+PC
Solar panel	5V/4.5W	5V/4.5W
Battery	3.2V/8000mAh	3.2V/8000mAh
Quantity of LED chips	30PCS	30PCS
Charge time	3-5H	3-5H
Color temperature	3000-6500K	3000-6500K
Size	Φ260*H310mm	Φ260*H300mm







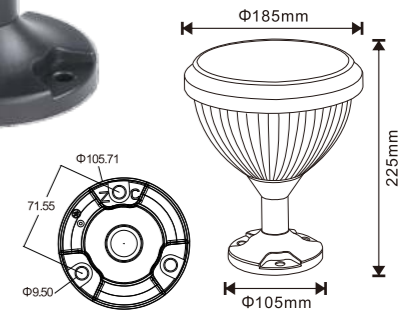
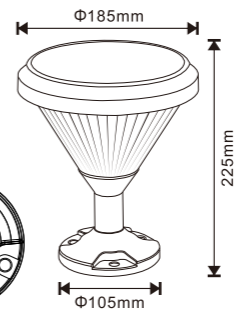

PRODUCT PARAMETERS

Model	ZC-BD6001	ZC-BD3001
Material	Die-casting aluminum+PC	Die-casting aluminum+PC
Solar panel	5V/5W	5V/4.5W
Battery	3.2V/6000mAh	3.2V/6000mAh
Quantity of LED chips	30PCS	20PCS
Charge time	3-5H	3-5H
Color temperature	3000-6500K	3000-6500K
Size	200*200*H240mm	Φ230*H275mm









-  Solar energy
-  3.2V Voltage
-  Optical sensing

PRODUCT PARAMETERS

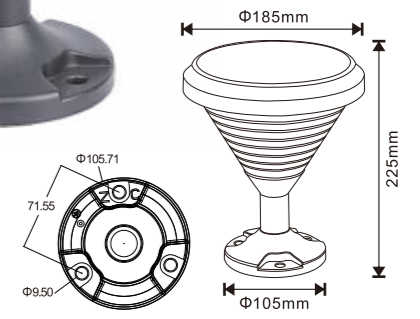
Model	ZC-ZTD0804	ZC-ZTD0705
Material	Die-casting aluminum+PC	Die-casting aluminum+PC
Solar panel	5V/2W	5V/2W
Battery	3.2V/3000mAh	3.2V/3000mAh
Quantity of LED chips	20PCS	20PCS
Charge time	3-5H	3-5H
Color temperature	3000-6500K	3000-6500K
Size	Φ185*Φ105*H225mm	Φ185*Φ105*H225mm





-  Solar energy
-  3.2V Voltage
-  Optical sensing

PRODUCT PARAMETERS

Model	ZC-ZTD0907	ZC-ZTD3004
Material	Die-casting aluminum+PC	Die-casting aluminum+PC
Solar panel	5V/2W	5V/2W
Battery	3.2V/3000mAh	3.2V/3000mAh
Quantity of LED chips	20PCS	20PCS
Charge time	3-5H	3-5H
Color temperature	3000-6500K	3000-6500K
Size	Φ185*Φ105*H225mm	Φ185*Φ105*H225mm



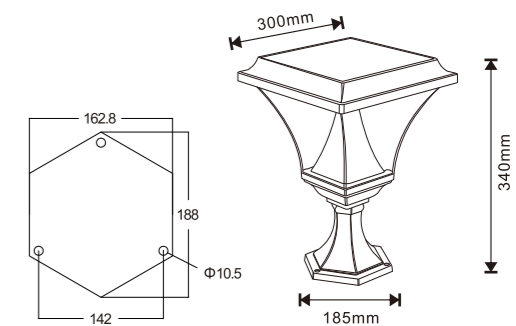
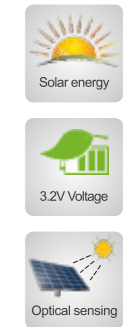

PRODUCT PARAMETERS

Model	ZC-ZTD4205
Material	Die-casting aluminum+PC
Solar panel	5V/10W
Battery	3.2V/12000mAh
Quantity of LED chips	60PCS
Charge time	3-5H
Color temperature	3000-6500K
Size	300*185*H340mm





New

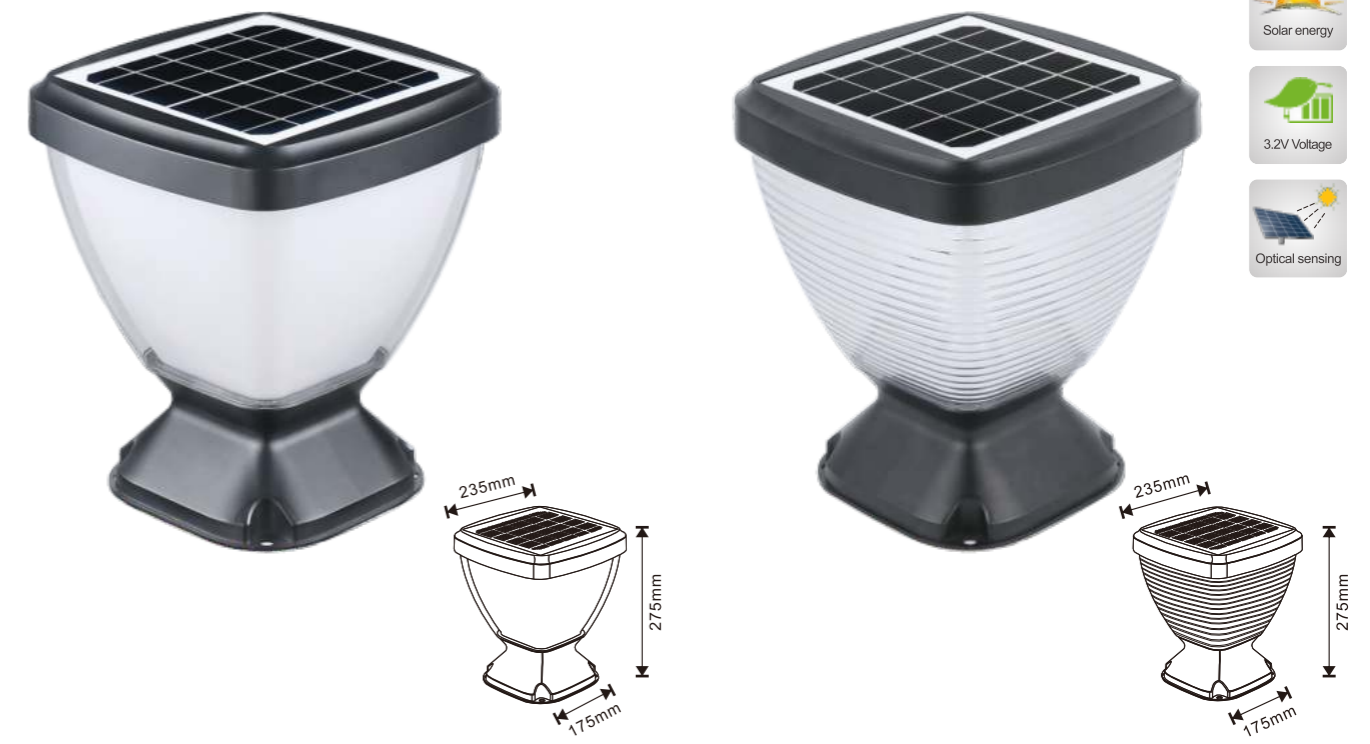

PRODUCT PARAMETERS

Model	ZC-ZTD1106-1	ZC-ZTD1106-2
Material	Die-casting aluminum+PC	Die-casting aluminum+PC
Solar panel	5V/5W	5V/5W
Battery	3.2V/8000mAh	3.2V/8000mAh
Quantity of LED chips	30PCS	30PCS
Charge time	3-5H	3-5H
Color temperature	3000-6500K	3000-6500K
Size	235*175*H275mm	235*175*H275mm



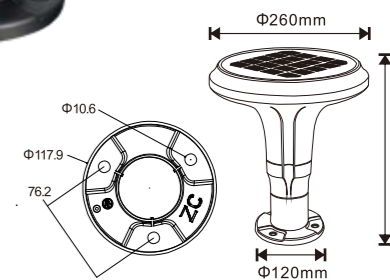

PRODUCT PARAMETERS

Model	ZC-ZTD5405	ZC-ZTD1004
Material	Die-casting aluminum+PC	Die-casting aluminum+PC
Solar panel	5V/4.5W	5V/4.5W
Battery	3.2V/8000mAh	3.2V/8000mAh
Quantity of LED chips	30PCS	12PCS
Charge time	3-5H	3-5H
Color temperature	3000-6500K	3000-6500K
Size	Φ260*Φ120*H330mm	Φ260*Φ120*H280mm



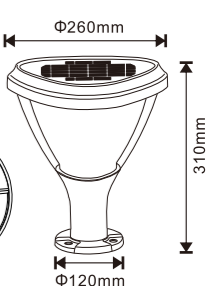
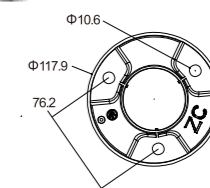
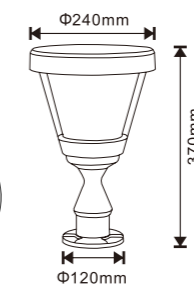
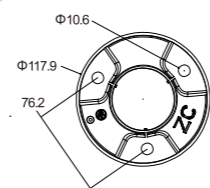

PRODUCT PARAMETERS

Model	ZC-ZTD2106	ZC-ZTD2104
Material	Die-casting aluminum+PC	Die-casting aluminum+PC
Solar panel	5V/4.5W	5V/4.5W
Battery	3.2V/8000mAh	3.2V/8000mAh
Quantity of LED chips	30PCS	30PCS
Charge time	3-5H	3-5H
Color temperature	3000-6500K	3000-6500K
Size	Φ240*Φ120*H370mm	Φ260*Φ120*H310mm





PRODUCT PARAMETERS

Model	ZC-ZTD4104	ZC-ZTD2204
Material	Die-casting aluminum+PC	Die-casting aluminum+PC
Solar panel	5V/4.5W	5V/4.5W
Battery	3.2V/8000mAh	3.2V/8000mAh
Quantity of LED chips	30PCS	30PCS
Charge time	3-5H	3-5H
Color temperature	3000-6500K	3000-6500K
Size	Φ260*Φ150*H250mm	Φ260*Φ150*H250mm



Electricity power series lamp effect picture



Garden light series



ZC-GGD2005



ZC-GGD003



ZC-TYD1104



ZC-GGD001



ZC-GGD002



ZC-GGD1105



ZC-TYD2403



ZC-TYD2705



ZC-TYD2505



ZC-GGD0805



ZC-TYD5108



ZC-TYD2808



ZC-TYD2806



ZC-TYD5106



ZC-TYD5105

Electricity power series lamp effect picture



Pole light series



ZC-GGD4505



ZC-GGD4105



ZC-GGD0203



97 ZC-GGD2806-1



ZC-GGD2806-2



ZC-GGD4205

Lawn light series



ZC-CPD2204



ZC-CPD2104



ZC-CPD5405



ZC-CPD1004



ZC-CPD2804



ZC-CPD5004



ZC-CPD3004



ZC-CPD2106



ZC-CPD4104



ZC-CPD110698

Electricity power series lamp effect picture



Wall lamp series



ZC-BD6001



ZC-BD3001



ZC-BD2106-1



ZC-BD2106-2



ZC-BD4001



ZC-BD1104



ZC-BD4005



ZC-BD1004



ZC-BD2104

Pillar light series



ZC-ZTD2104



ZC-ZTD2106



ZC-ZTD5405



ZC-ZTD1004



ZC-ZTD4104



ZC-ZTD2204



ZC-ZTD1106



ZC-ZTD4205